

Grad-/Vollbartschlüssel Art.Nr. **98/0** ...

und

**98/4/0** ...

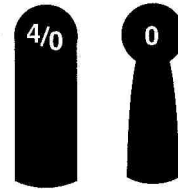

Ø	L	P
7	100	27
7,5	110	27,5
7	120	27
8	120	28
8	130	28
8,5	140	28,5
9	150	29

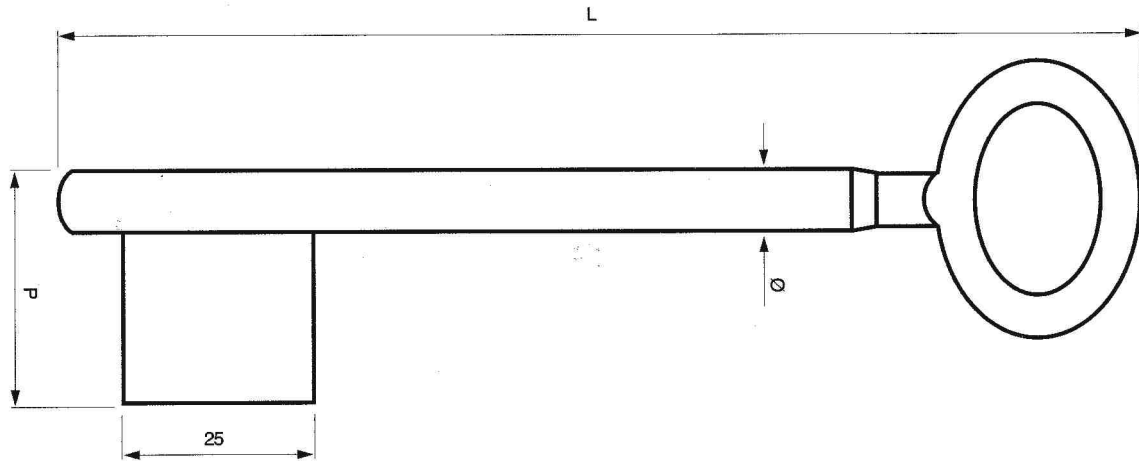

Möbelschlüssel mit geraden Bärten

Art.Nr. **173 / 176**

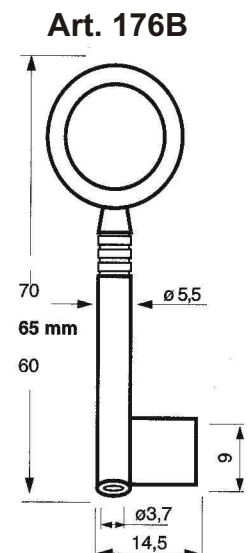
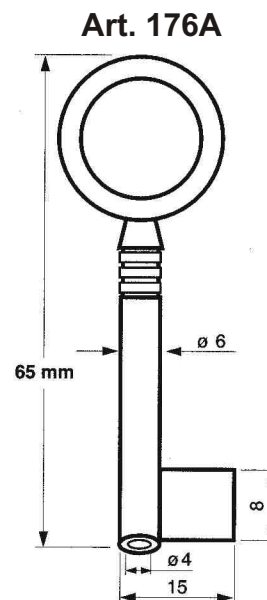
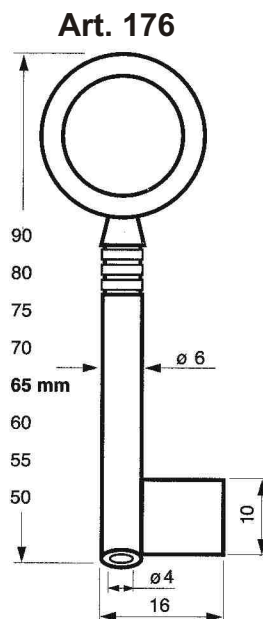
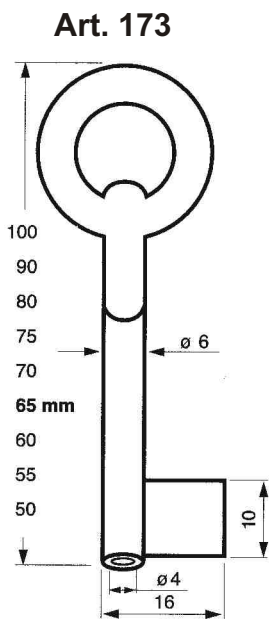

**Achtung !** Bei der Bestellung immer die Halmlänge mit angeben.  
Bei fehlender Halmlängenangabe wird die gängige Länge geliefert.  
( fett abgedruckte Zahl )

Fortsetzung Möbelschlüssel mit geraden Bärten

Möbelschlüssel mit geraden Bärten

Art.Nr. **176 / 177 / 180**

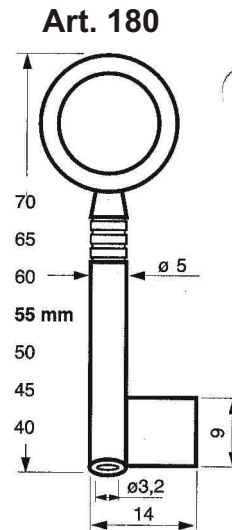
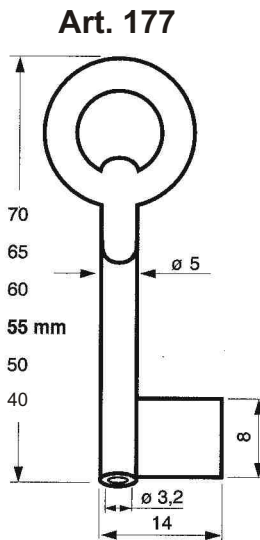
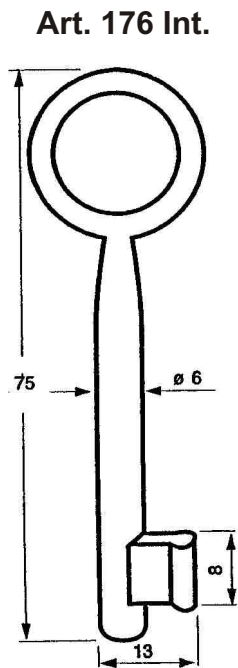

Möbelschlüssel mit geraden Bärten Art.Nr. **191 / ..**

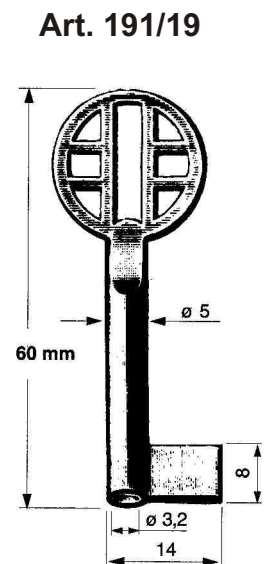
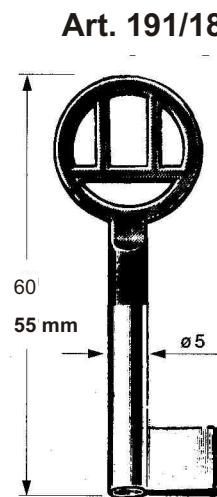
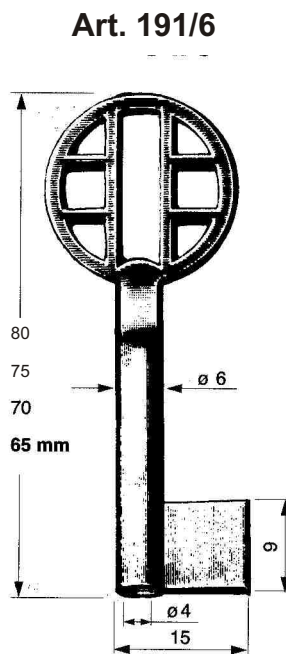
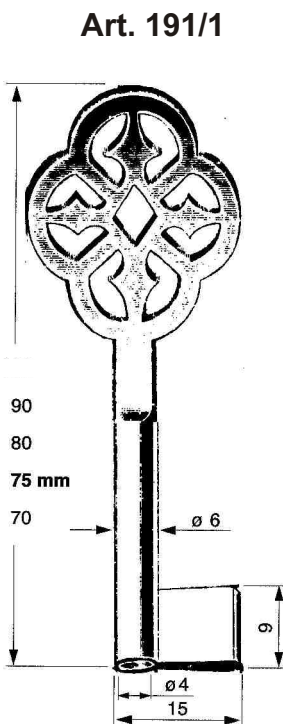

**Achtung !** Bei der Bestellung immer die Halmlänge mit angeben.  
Bei fehlender Halmlängenangabe wird die gängige Länge geliefert.  
( fett abgedruckte Zahl )

**Möbelschlüssel mit Bartformen ( Nuten- und Chubbform )**

**Art.Nr. 176 /-... N + CH**

Art. 176/N6/ Nr. 1-4

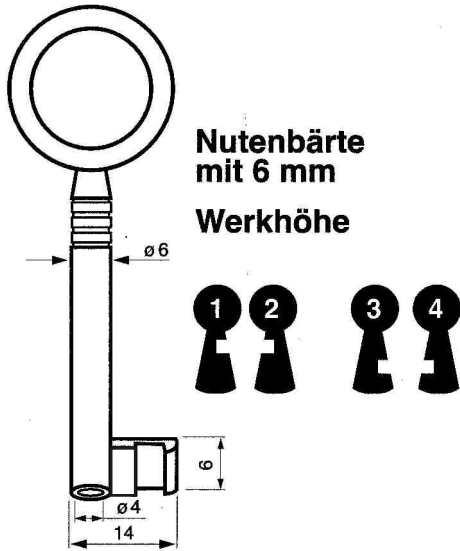

Art. 176/N8/ Nr. 1-4

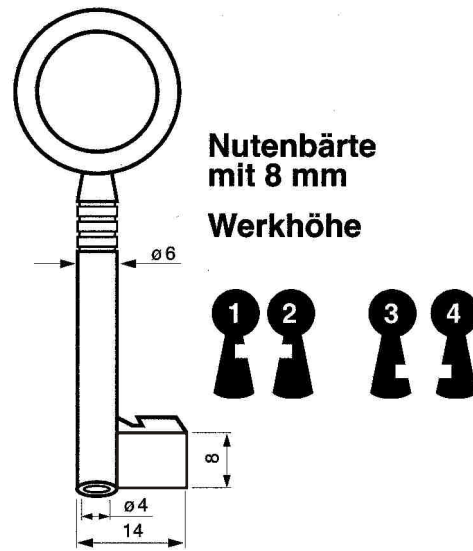

Art. 176/CH6/ Nr. 1-6

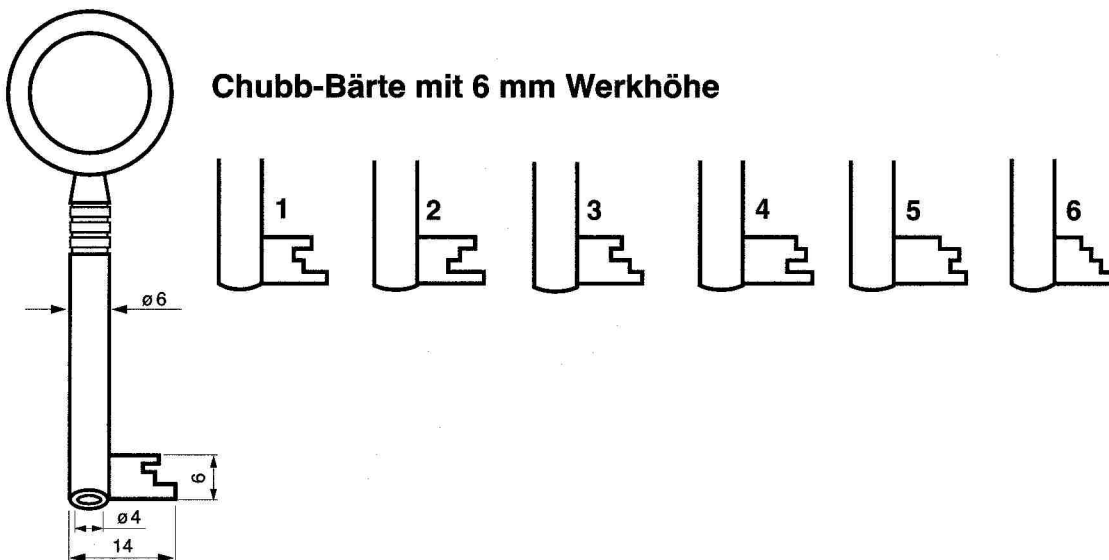

**Achtung ! Bitte immer jeweilige Bartform-Nummer angeben.**

**Beispiel :**

Zum Bestellen des Chubbschlüssel Nr. 6 in 6mm Werkhöhe lautet die Artikelnummer wie folgt : **176 / CH6 / Nr. 6**

**Möbelschlüssel mit Bartformen ( Nuten- und Chubbform )**

**Art.Nr. 176 CH8 / 180-... N + CH**

Art. 176/CH8/ Nr. 1-6

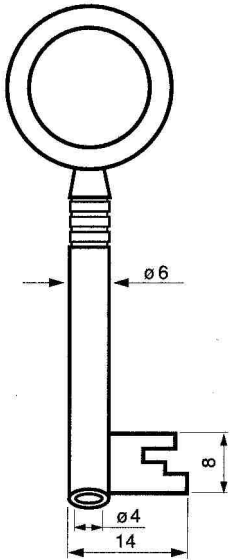

**Chubb-Bärte mit 8 mm Werkhöhe**

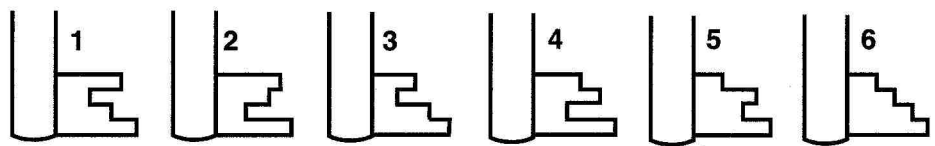

Art. 180/N/ Nr. 1-4

**Nutenbärte zierlich**

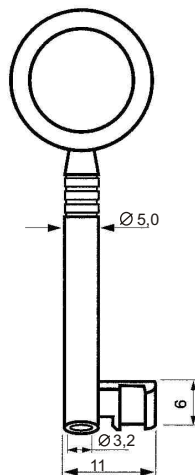
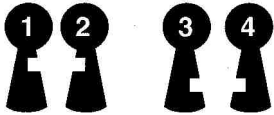

Art. 180/CH/ Nr. 1-6

**Chubb-Bärte zierlich**

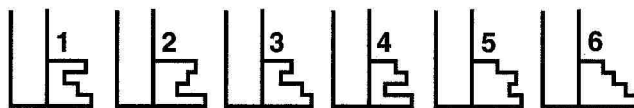
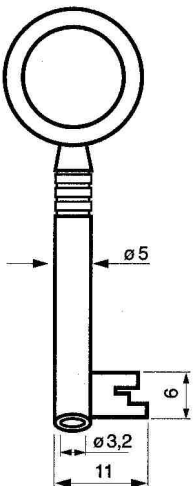

## Schrankschlüssel geschwärzt Art.Nr. 181-...

Tiefgebohrt, gerader Bart ( kein Vollbart )

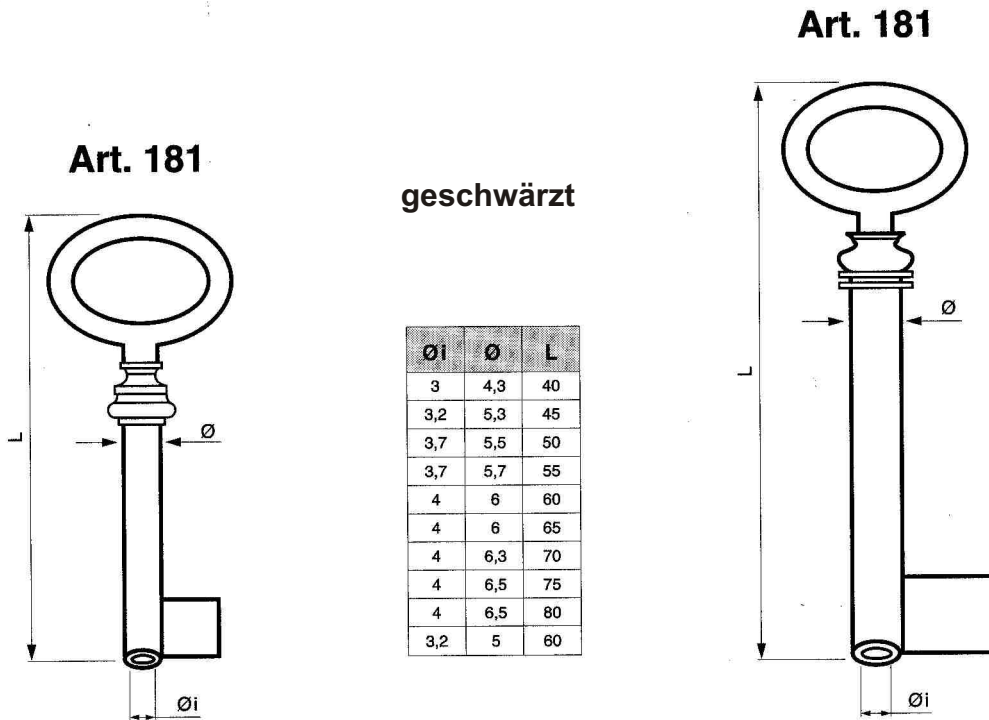

## Schrankschlüssel geschwärzt Art.Nr. 182-...

Durchgehend, gerader Bart ( kein Vollbart )

